

PART NO : H6682-06

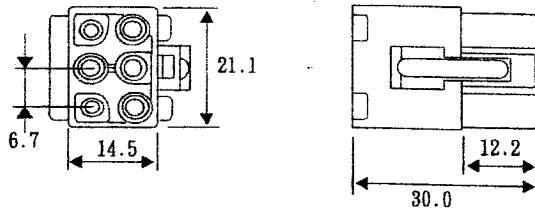

PART NO : H6683-06, H6683E-06

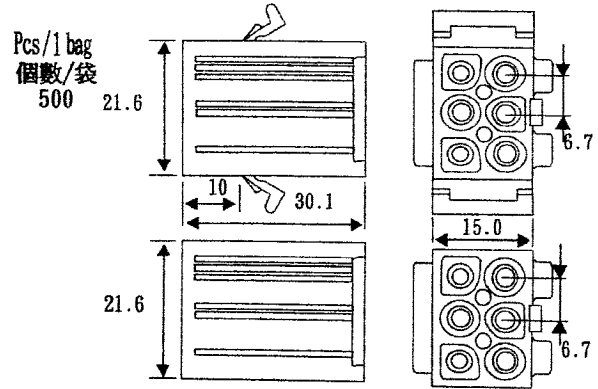

PART NO : H6682-09

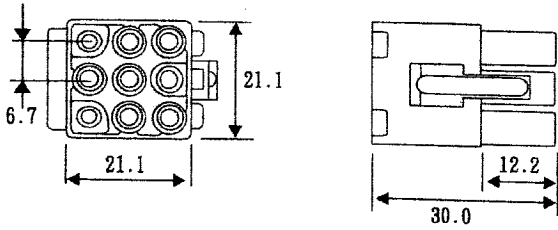

PART NO : H6683-09, H6683E-09

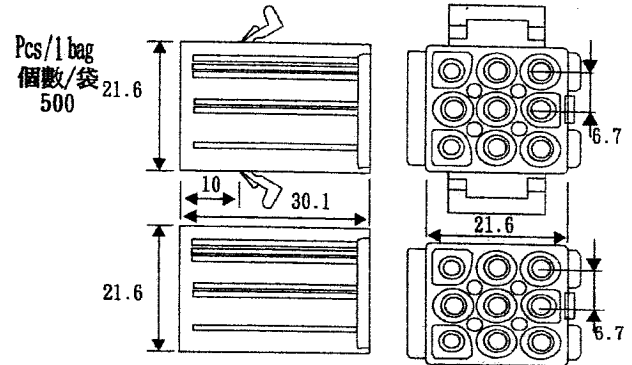

PART NO : H6682-12

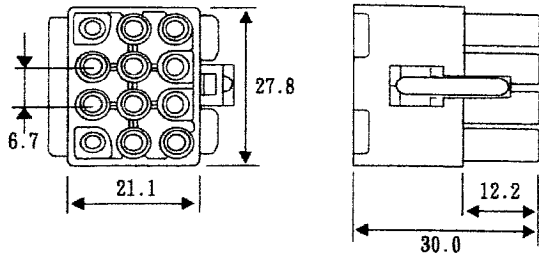

PART NO : H6683-12, H6683E-12

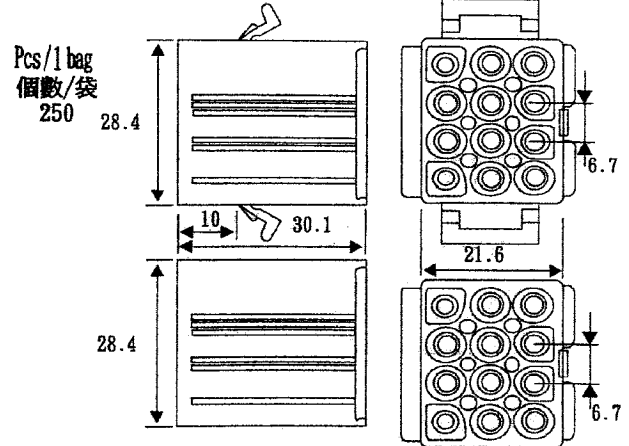

PART NO : H6682-15

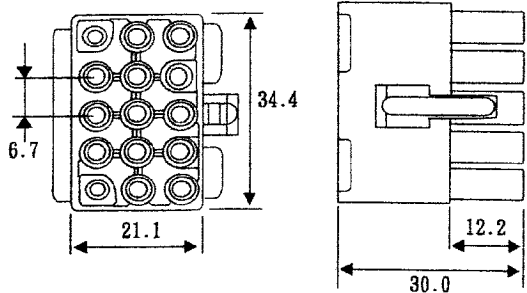

PART NO : H6683-15, H6683E-15

