

.165"(4.20mm) pitch Power connectors



CH4202 Series

- * Poles: 2-24
- * Material: NYLON 66 UL94V-2
- * Suitable CT4202 Series Terminal
- * Mates with CH4201 Series Housing Specifications
- * Current rating: 8A AC, DC
- * Voltage rating: 500V AC, DC
- * Temperature range: -25°C ~ +105°C
- * Insulation resistance: 1,000MΩ min.
- * Withstand voltage: 1,500V AC/minute

P/N: CH4202-2xXX

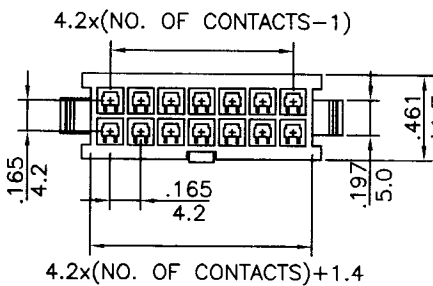

panel hole dimensions

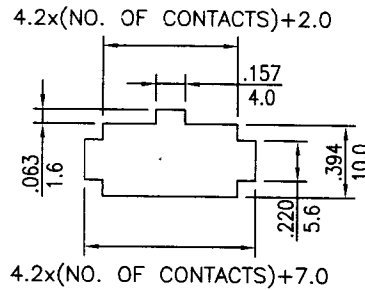

inches
mm

P/N: CH4202N-2xXX
SPECIAL TYPE

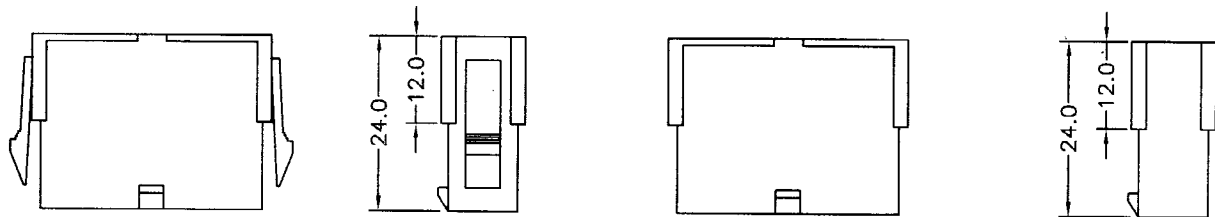
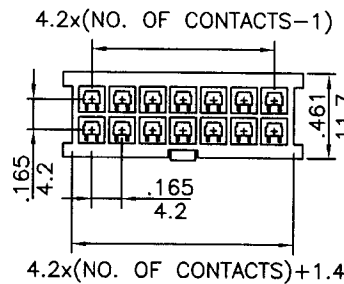

.165"(4.20mm) pitch crimp terminal

CT4202 Series

- * Material: Brass
- * Finished: Tin-plated
- * Used in CH4202 series housings
- * Wire range: CT4202T: AWG#18~22
CT4202HT: AWG#16~18
- * Insulation O.D.: 3.00mm(max)
- * Thickness: 0.20mm
- * Q'TY: 5,000pcs/reel

inches
mm

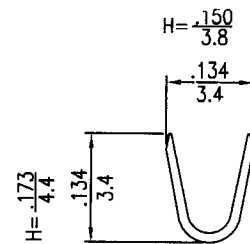

A-A SECTION

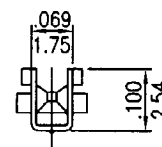
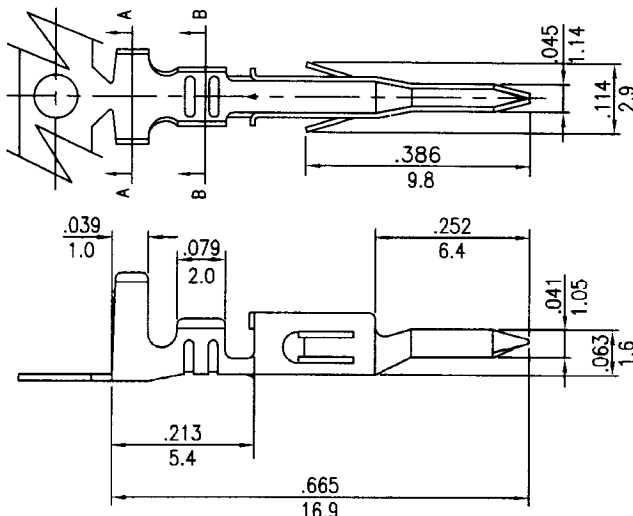

B-B SECTION