

PART NO: H66L5-01

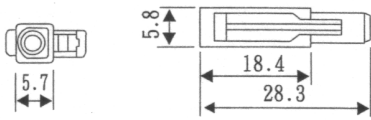

PART NO: H66L6-01

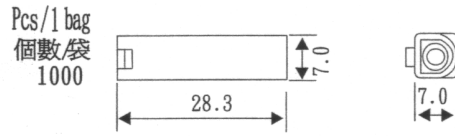

PART NO: H66L5-02

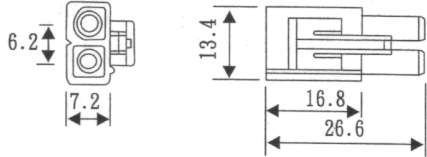

PART NO: H66L6-02, 66L6E-02

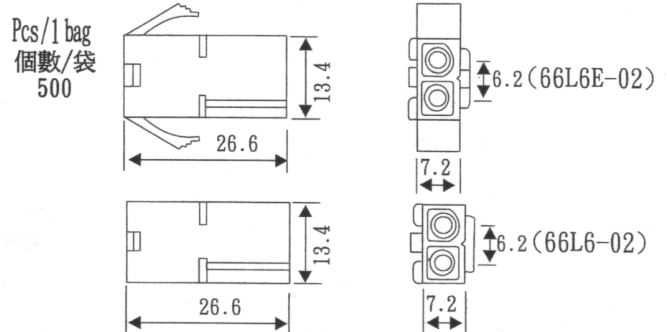

PART NO: H66L5-03

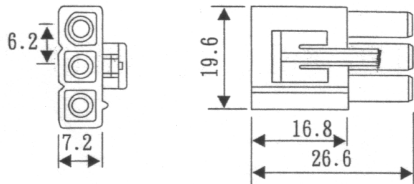

PART NO: H66L6-03, 66L6E-03

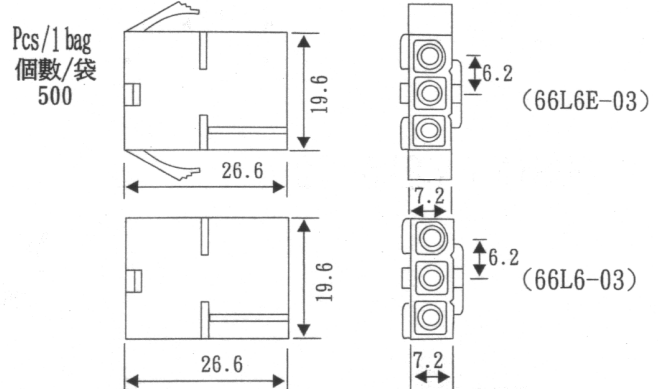

PART NO: H66L5-04(1\*4)

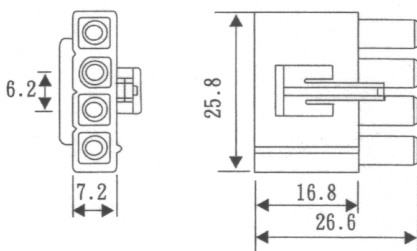

PART NO: H66L6-04, 66L6E-04

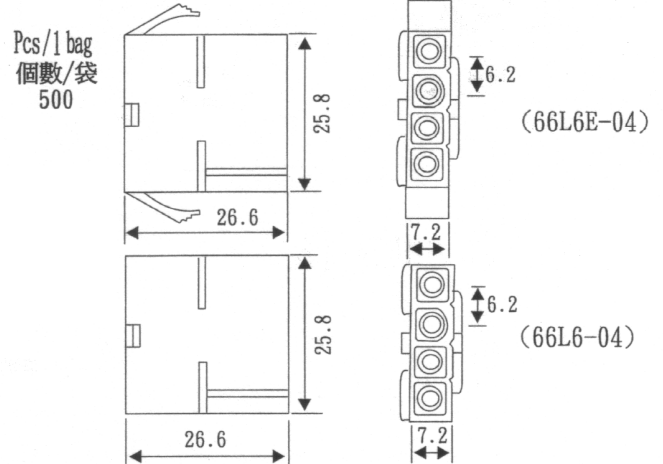

PART NO: H66L5-2x2

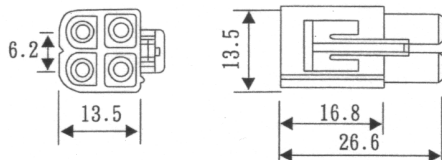

PART NO: H66L6-2x2, 66L6E-2x2

